

SIEMENS



RDS110

Smart Thermostat

User Guide

Table of Contents

1	About this User guide	5
1.1	Revision history	5
1.2	Reference documents.....	5
1.3	Before you start	6
2	Summary	8
2.1	Brief description.....	8
2.2	Inbox items.....	8
2.3	Equipment combinations.....	8
3	Mounting and installation	11
4	Getting started with your thermostat	14
4.1	Setup wizard.....	14
4.2	Thermostat display overview.....	15
4.3	Home screen icon overview	17
5	Presence detection	18
5.1	Presence detection using the built-in PIR sensor.....	18
5.2	Approach detection.....	19
6	Operating the thermostat on the device	21
6.1	Temperature control	21
6.2	Operating modes	22
6.2.1	Operating modes with manual switchover	22
6.2.2	Operating modes in a scheduler.....	23
6.3	WLAN connection.....	23
6.4	Screen lock protection	25
6.4.1	Locking the home screen	25
6.4.2	Creating an administrator password	25
6.5	Turning on/off the supply of domestic hot water	26
6.6	Basic settings	26
6.6.1	Turning on/off the touch sound.....	27
6.6.2	Changing the display language	27
6.6.3	Naming a room	27
6.7	Advanced settings	27
6.7.1	Changing a time zone	28
6.7.2	Managing application settings	28
6.7.3	Changing system setup.....	36
6.7.4	Checking the basic information about your thermostat.....	38
6.8	Software updates.....	38
7	Green leaf indication	39
8	Air quality display	40
9	Operating the thermostat from the mobile app	41
9.1	Downloading the app	41
9.2	Account creation and pairing.....	41

9.3	Changing background color	42
9.4	Managing the information about your thermostat remotely.....	42
9.5	Widget overview	43
9.5.1	Temperature control widget overview	43
9.5.2	Domestic hot water widget overview.....	45
9.5.3	Running hours widget overview	45
9.6	Temperature control	46
9.7	Turning on/off the supply of domestic hot water.....	47
9.8	Switching between Away and At home.....	47
9.9	Setting schedulers	47
9.10	Switching between heating and OFF modes	49
10	Disassembly and disposal	50
11	Appendices.....	51
11.1	Frequently asked questions	51
11.1.1	What should I do if I forget the screen lock code?.....	51
11.1.2	What if two users change the same setting at the same time?	51
11.1.3	Will the thermostat work if the connection to the cloud is lost?	51
11.1.4	Why does the scheduled Eco mode change to Comfort?	51
11.1.5	What is the difference between Administrated WLAN and Private WLAN?	52
11.1.6	What if the WLAN network is down during software updates?.....	52
11.1.7	Can I change the Green leaf settings?	52
11.1.8	Can I change the air quality measurement standard?	52
11.1.9	Where can I check the current time on the thermostat?	52
11.1.10	Can the thermostat display the time correctly if there is no WLAN connection?	53
11.1.11	Can I set the time manually?	53
11.1.12	Why is the time displayed incorrectly even though the thermostat is added to a WLAN network?	53
11.1.13	How does the built-in PIR sensor work?	53
11.1.14	What does the Pump/valve kick function mean?	53
11.1.15	I've registered an account but cannot log in.	53
11.1.16	I've signed up but have not received a confirmation email.....	53
11.1.17	Can I create more than one user account in the mobile app?	54
11.1.18	What should I do if I forget my account's password?	54
11.1.19	How long are date and time valid, if power fails and the thermostat has no connection to the cloud?.....	54
11.1.20	How does Optimum start control work?	54
11.1.21	How does Adaptive gain control work?	54
11.1.22	How long are settings saved in the thermostat if power fails?	54
11.1.23	How does self-heating compensation work?	54
11.1.24	How does the thermostat adapt start optimization of outside temperature?	55
11.1.25	How does the temperature switching differential work?.....	55
11.2	Technical specifications	55
11.3	Cyber security disclaimer.....	55
11.4	Limited warranty	55

1 About this User guide

1.1 Revision history

Edition	Date	Changes	Section
4	January 2019	Added information on safety of mounting and installation.	3
3	April 2018	Third edition. Thermostat software version 32.2.27 or higher. <ul style="list-style-type: none"> Added information on safety of mounting and installation. Added notes regarding use of RVS wire. Added information on time synchronization and setting valid period after power failure. Added information on self-heating compensation. Added information on optimization of outside temperature. Added information on temperature switching differential. 	3 11.1.19 11.1.20 11.1.21 11.1.22 11.1.23 11.1.24 11.1.25
2	March 2018	Second edition. Thermostat software version 32.2.18 or higher. <ul style="list-style-type: none"> Caution: Changed operating modes from Comfort, Pre-comfort and Economy to Comfort, Economy and Unoccupied. Adapted default behavior of Room presence detection function. Deleted information on generation of short circuits upon incorrectly configured thermostat entering OFF mode. Information on running hours widget. Information on support of background color changes on mobile app. Information on humidification/dehumidification control. 	5.1 6.2.1 6.2.2 6.7.2 6.7.3 7, 9.9 9.3 9.5, 9.5.3 11.1.4
1	August 2017	First edition. Thermostat software version 32.2.10.	All

1.2 Reference documents

Ref.	Document title	Document number
[1]	Mounting instructions	A6V10733796
[2]	Quick guide	A6V10733808
[3]	Data sheet	A6V10807602

You can download the above documents from <http://siemens.com/bt/download> by searching the document numbers listed above.

1.3 Before you start

Trademarks

The table below lists the third-party trademarks used in this document and their legal owners. The use of trademarks is subject to international and domestic provisions of the law.

Trademarks	Legal owner
App Store®	Apple Inc.
Google Play™	Google Inc.
Wi-Fi®	Wi-Fi Alliance

All product names listed in the table are registered (®) or not registered (™) trademarks of the owner listed in the table. We forgo the labeling (e.g. using the symbols ® and ™) of trademarks for the purposes of legibility based on the reference in this section.

Copyright

This document may be duplicated and distributed only with the express permission of Siemens.

Quality assurance

These documents were prepared with great care.

- The content of all documents is checked at regular intervals.
- All necessary corrections are included in subsequent versions.
- Documents are automatically amended as a consequence of modifications and corrections to the products described.

Please make sure that you are aware of the latest document revision date.

If you find any lack of clarity while using this document, or if you have any criticisms or suggestions, please contact your local point of contact (POC) at the nearest branch office. Addresses for Siemens RCs are available at www.siemens.com/sbt.



Conventions for text marking

Markups

Special markups are shown in this document as follows:

▷	Specifies the requirements that must be met before performing this procedure.
1. 2.	Procedures must be performed in the specified order.
[→ X]	Reference to a page number
>	Relation sign and for identification between steps in a sequence, e.g., Menu bar > Help > Help topics.

Symbol identifications

	⚠ WARNING
	This is the symbol for hazard. It warns you of Risks of injury . Comply with all measures designated by this symbol to prevent injury or death.
	NOTICE
	This symbol identifies an important notice that you should be aware of when you are using the product.



The 'i' symbol identifies supplementary information and tips for an easier way of working.

Document use/ request to the reader

Before using products from Siemens Industry, Inc., it is important that you read the documents supplied with or ordered at the same time as the products (equipment, applications, tools, and so on) carefully and in full.

Before you get started, make sure you have an internet connection, a valid Email address and a smartphone in hand.

Additional information on products and applications is available:

- At your Siemens branch office www.siemens.com/sbt or at your system suppliers.
- From the support team in the headquarters fieldsupport-zug.ch.sbt@siemens.com if no local POC is available.

Siemens assumes no liability to the extent allowed under the law for any losses resulting from a failure to comply with the aforementioned points or for the improper compliance of the same.

2 Summary

2.1 Brief description

Smart Thermostat RDS110 is designed to control your heating system in apartments, single family homes, dormitories and other residential-type as well as light commercial spaces. Apart from traditional operations performed directly on the hardware unit, remote operations that use a mobile app are also allowed for your convenience.

2.2 Inbox items

Items	Quantity
Thermostat (front and rear)	1
Metallic mounting plate	1
Set of screws and plastic insert	1
Quick guide	1
Mounting instructions	1
Activation code sticker	1
Wiring sticker	1

2.3 Equipment combinations

Remote sensors

Type of unit	Product no.	LG- Ni1000 at 0 °C	Pt1000 at 0 °C	NTC 10k at 25 °C	DC 0...10 V	Datasheet *
Room temperature sensors						
- Wall-mounted	QAA24	x				1721
	QAA2012		x			1745
	QAA2030			x		1745
	QAA2061				x	1749
	QAA2061D ²⁾				x	1749
- Flush-mounted ¹⁾	AQR2531AN W	x				1408
	AQR2532N NW				x	1411
- Concealed	QAA64 (vandal- proof)	x				1722
Outdoor temperature sensors						
	QAC22	x				1811
	QAC2012		x			1811



Type of unit	Product no.	LG-Ni1000 at 0 °C	Pt1000 at 0 °C	NTC 10k at 25 °C	DC 0...10 V	Datasheet *
	QAC2030			x		1811
	QAC3161				x	1814
Cable temperature sensors						
	QAP21.3	x				1832
	QAP22	x				1831
	QAP21.3/8000	x				1832
	QAP2012.150		x			1831
	QAP1030.200			x		1831
Room humidity sensors						
- Wall-mounted	QFA2000				x	1857
- Wall-mounted including temperature	QFA2020	x (T)			x (r.h.)	1857
	QFA2060				x (T+r.h.)	1857
	QFA2060D ²⁾				x (T+r.h.)	1857
- Flush-mounted ¹⁾ including temperature	AQR2534ANW + AQR2540Nx	x (T)			x (r.h.)	1410
	AQR2535N NW + AQR2540Nx				x (T+r.h.)	1410





* The documents can be downloaded from <http://siemens.com/bt/download> by specifying the product number as shown in the above table.

1) Requires a mounting plate and/or design frames.

2) With digital display.

Actuators

Type of unit	Product no.	Datasheet*
Electromotoric actuator	 SFA21/18	4863
	 SUA21/3	A6V10446174

Type of unit		Product no.	Datasheet*
Electrothermal actuator (for radiator valves) AC 230 V, NO		STA23..	4884
Electrothermal actuator (for radiator valves) AC 24 V, NO		STA73..	4884
Electrothermal actuator AC 230 V (for small valves 2.5 mm), NC		STP23..	4884
Electrothermal actuator AC 24 V (for small valves 2.5 mm), NC		STP73..	4884

Accessory

Type of unit		Product no.	Datasheet*
White decoration frame and metallic mounting plate for installation on rectangular conduit box (1 set)		ARG100.01 S55772-T102	A6V1119064 0

* The documents can be downloaded from <http://siemens.com/bt/download> by specifying the product number as shown in the above table.

3 Mounting and installation

Mounting

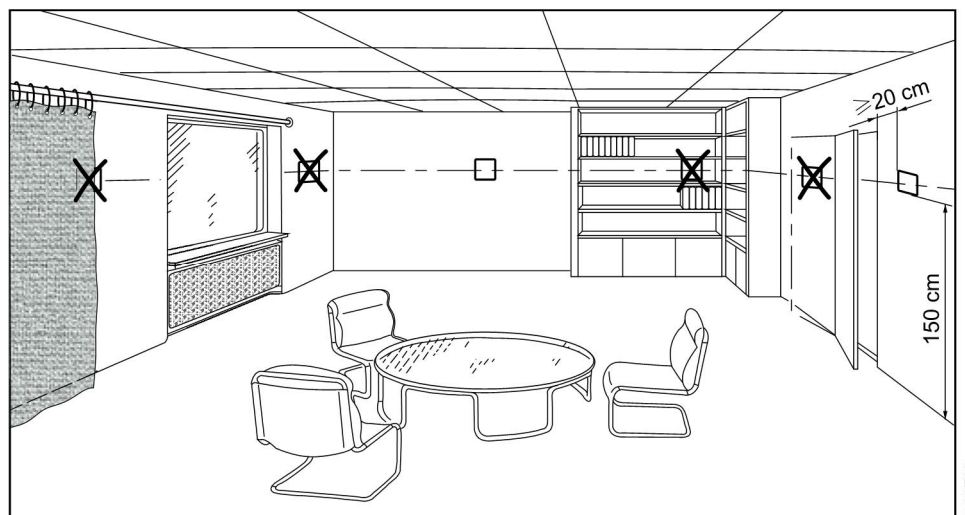

NOTICE

We recommend hiring licensed installers to mount and install the thermostat.

- The thermostat is suitable for wall mounting.
- The recommended height is 1.50 m above the floor.
- Do not mount the thermostat in recesses, shelves, behind curtains or doors, or above or near heat sources.
- Avoid direct solar radiation and drafts.
- Seal the conduit box or the installation tube if any, as air currents can affect sensor readings.
- Adhere to allowed ambient conditions.

Installing your thermostat

1. Switch off power to your heating system by using either your home's breaker box or the system's power switch.

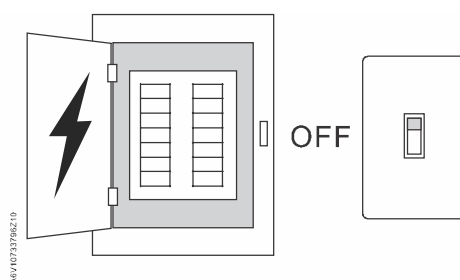

2. Remove the cover of your old thermostat.
3. Label the wires according to your old thermostat terminal designations, using the stickers provided together with the thermostat. It is also helpful if you take a picture of the current wire connections for reference later on.

L	L	X1	Q11	Q12	Q21	Q24
L	L	X1	Q11	Q12	Q21	Q24
N	N	X2	Q11	Q14	Q22	M
N	N	X2	Q11	Q14	Q22	M

4. Disconnect all the labeled wires and then remove your old thermostat. **NOTICE! Do not dispose of your old thermostat as part of household if it contains mercury in a sealed tube. Contact a thermostat recycling organization, for example, www.thermostat-recycle.org, for safe disposal of your old thermostat.**
5. Check whether you need to have more wires connected to the power unit to be installed. If so, prepare the wires and label them accordingly. Normally, at least three wires are needed for the thermostat to work properly. We strongly recommend to hire installers to connect the wires.
6. Seal the conduit box or the installation tube to prevent entry of cold or hot air and make sure the temperature readings of the internal sensor are correct.
7. Screw the mounting plate tightly on the conduit box using a screwdriver, make sure the mounting plate is placed correctly (part with the upward arrow placed on the top).

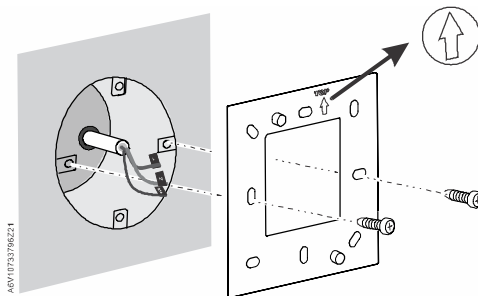

8. Connect tightly the labeled wires to the terminal as per your thermostat terminal designations (see picture in Step3), and tighten all inserted wires by screwing down the screws. Note that the wiring for your application may differ from the drawing below.

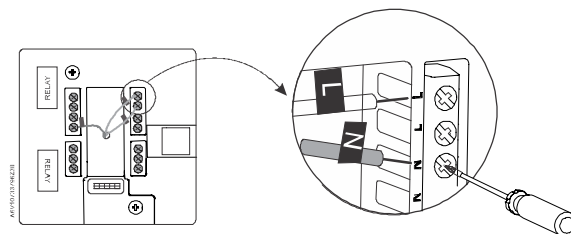

9. Screw the power unit on the mounting plate tightly.

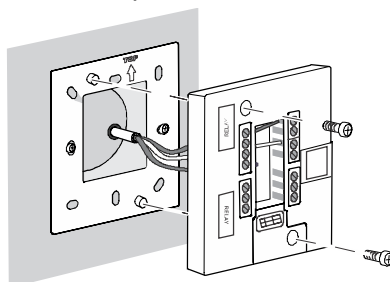

10. Attach the front module horizontally. Ensure that each side of the front module aligns with the power unit and press the corners in the order illustrated below: Top (1); bottom (2) until each corner clicks in place. Note: You must discharge static electricity from your body before mounting the front module. For example, touching the wall can help discharge static electricity.

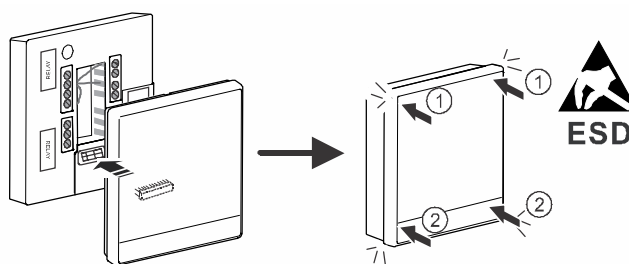

11. Switch on power to your heating system. Your thermostat powers on too.

Wiring



See the [Mounting instructions](#) for more information. Note that a bridge between one Q11 terminal and terminal L is pre-wired. Do not remove this pre-wired bridge unless required.

- Comply with local regulations to wire, fuse and earth the thermostat. Connect the conduit box to earth (safety ground).
- Adapt the line diameters as per local regulations to the rated value of the installed overcurrent protection device.
- The line voltage cables and signal cables must be arranged separately.
- X1, M and X2 wires operate at SELV (Safety Extra Low Voltage) level. Do not insert cables with AC 230 V mains voltage into terminals X1, M and X2 and vice versa.
- Isolate the cables of inputs X1, M and X2 from AC 230 V mains voltage.
- The AC 230 V mains supply line must have an external circuit breaker with a rated current of no more than 10 A.
- Screw down all terminals regardless of whether cables are connected or not.
- Do not tear off the two insulation tapes on the lower part of the rear of the power unit, as it may cause electric shock.
- Properly size the cables to the thermostat and valve actuators.
- Screw down the cables tightly and make sure no bare copper is exposed.
- Use valve actuators rated for AC 230 V. If a valve actuator rated for AC 24 V is used, use a transformer before connecting it to the thermostat.
- Disconnect from power supply before removing the front module and the mounting plate.
- Use a cable lug to avoid touching of mains and neutral wires, if the power cable is made of RVS wires.

4 Getting started with your thermostat

4.1 Setup wizard

When your thermostat is powered up for the first time, a setup wizard displays to guide you through the following procedures:

- Setting a display language
- Setting an administrator password
- Setting up a network connection and choosing the network connection type
- Selecting an equipment type and setting up the details
- Configuring time and date
- Specifying a name to the location where the thermostat is installed

For more details, see the [Quick guide](#).

4.2 Thermostat display overview

Normal display



1	Tap to display detailed information and additional settings.
2	Displays whether the system is in an energy-optimized mode. If the leaf is red, predefined settings were changed. Tap the red leaf to restore the energy-saving mode. The leaf again turns green.
3	Room temperature.
4	Tap to toggle between At home and AWAY .
5	Displays whether the thermostat is following a scheduler (AUTO) or following your setpoint changes permanently (🔒). Following a scheduler can mean the following: <ul style="list-style-type: none"> • If there is network connection and you've also set your scheduler, the thermostat follows your scheduler. Your temporary change of the temperature setpoint only takes effect during the currently scheduled mode. • If network is connected but no scheduler set, the thermostat applies the system's default scheduler. For more information on the default scheduler, see Setting schedulers [→ 47]. • Without network connection or valid time, the thermostat cannot retrieve scheduler information from the Cloud. It always works under the Comfort mode.
6	Tap or slide to change the room temperature setpoint.













Idle display



1	Relative room humidity
2	Shows room air quality: <ul style="list-style-type: none"> • If the icon is green, the air quality is good. • If the icon is orange, the air quality is moderate. • If the icon is red, the air quality is poor. To ensure room air quality is measured accurately when the room is closed for a long time, forced air circulation such as opening a window is recommended.
3	Indicates the system is in an energy-optimized mode. If the leaf is red, predefined settings were changed. Tap the red leaf to restore energy-saving mode. The leaf turns to green.
4	Room temperature.

NOTE: The icons displayed in idle mode may differ under different scenarios.

4.3 Home screen icon overview

Icon	Description
	The device is connected to the cloud but not associated with an account.
	At home mode is on.
	AWAY mode is on. You must manually tap  to activate this mode.
	Displays when the system works in an energy-optimized mode. If the leaf is red, it means that some pre-defined settings have been changed. You can tap the red leaf to restore to the energy-saving mode. The leaf turns green again.
	Temperature setpoint slider. The background color of this icon changes along with major changes to the setpoints: <ul style="list-style-type: none"> • If you increase the setpoint by dragging the slider to the right to warm up the room, the slider color changes to orange. • If no heating occurs, the slider color changes to white.
	Relative room humidity
	The thermostat works following a scheduler. If you haven't set one, the thermostat works following a default scheduler. This default scheduler could be set by the system, or specified by yourself if you have changed the default setpoints of some operating modes under Advanced Settings > Optimization . When this icon is toggled on, temperature setpoint changes can only be maintained within the current scheduled mode and will be overridden to the scheduled setpoint when the next scheduled mode starts. NOTE: If the thermostat has never been connected to a WLAN network, it cannot read the real time from the network and thus cannot follow a scheduler. In this case, it always works under the Comfort mode.
	The thermostat doesn't work following a scheduler. All of your temporary setpoint changes work continuously if this icon is toggled on.
	Tap to display options, such as Operation Mode , Settings and Advanced Settings .
	Indicates that room air quality is good.
	Indicates that room air quality is okay.
	Indicates that room air quality is poor.

5 Presence detection

5.1 Presence detection using the built-in PIR sensor

By using a built-in presence detection sensor (also called PIR (Passive infrared detector) sensor), the thermostat detects occupancy and then does the following:

- Activates idle display. When no operations are performed, the thermostat detects presence in room. Upon presence, it displays information such as room temperature, room air quality and relative room humidity. If unoccupied, it turns off the screen.
- Changes the operating mode from **Unoccupied** to **Comfort**. If presence is detected in a formerly unoccupied room during a scheduled **Unoccupied** period, the thermostat switches to **Comfort** automatically until the next scheduled mode starts. However, this function is disabled by default and must be enabled manually if so desired.

Sensor location

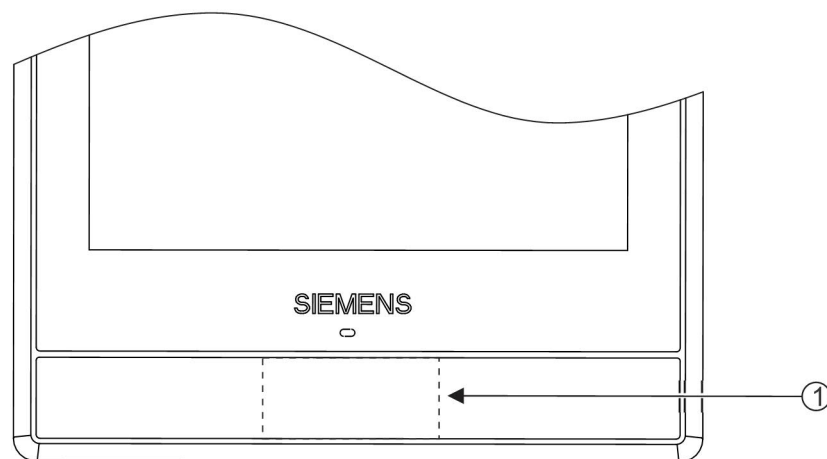





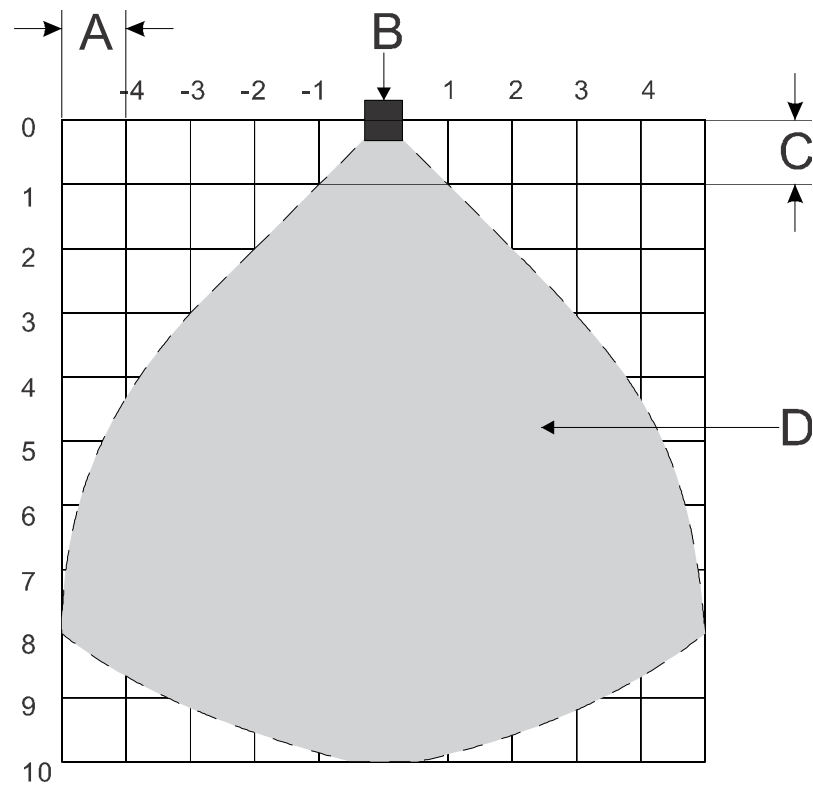

- | | |
|---|--|
| 1 | The location of the PIR sensor. It is a black area if seen from the front of the front module. |
|---|--|

Sensor detection range



A	The width of each cell. It is 80 cm (31 in).
B	The thermostat.
C	The height of each cell. It is 80 cm (31 in).
D	The area that the PIR sensor can detect.

Change from Unoccupied to Comfort when an unoccupied room becomes occupied

1. On the Home screen, tap , tap  and then tap .
2. If prompted, enter the administrator password.
3. Tap , tap , and then tap . Scroll down and tap **Room presence detector**.
4. Drag the slider to the right.

5.2 Approach detection

The thermostat has a built-in approach sensor. It can detect someone approaching the thermostat. If activity is sensed within 10 cm, it will switch from its idle screen to the main home screen with full temperature and setpoint display.

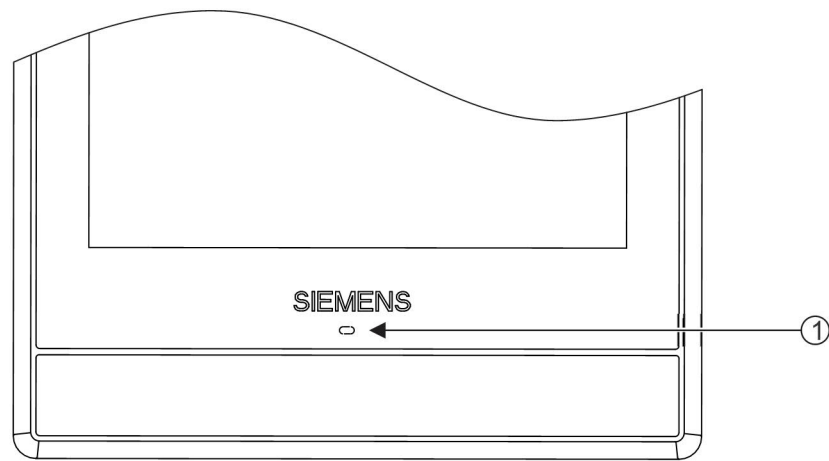
Sensor position

1	The location of the approach sensor.
---	--------------------------------------

6 Operating the thermostat on the device

6.1 Temperature control

Your thermostat acquires the room temperature using the built-in sensor and/or the external room temperature sensor, and maintains the setpoint by delivering control commands to heating equipment. On the home screen, you can see the current room temperature and adjust the temperature setpoint as you want.



Your thermostat also allows you to select your preferable temperature unit between °C (the default unit) and °F.

!	NOTICE
	After the initial setup of the thermostat, the displayed room temperature may not be correct because the temperature sensors need time for the calibration. Wait for at least one hour for the calibration.

Adjust the temperature setpoint on the home screen

- On the Home screen, drag the temperature slider to the right to increase the temperature setpoint, or to the left to decrease the temperature setpoint.





Change the temperature unit

1. On the Home screen, tap , and then tap >.
2. Tap , then tap °C to change from Celsius to Fahrenheit, or tap °F to change from Fahrenheit to Celsius.

6.2 Operating modes

6.2.1 Operating modes with manual switchover

Operating mode overview





Operating mode	Description
At home	<p>You can use this mode when you stay at home or inside the room where the thermostat is located.</p> <p>When the thermostat operates under this mode, you can toggle to  to let the thermostat run automatically following a scheduler, or toggle to  to let the thermostat operate at a specified setpoint permanently. See Thermostat display overview [→ 15] for more detailed information about how the thermostat works when  or  is toggled on.</p>
AWAY	<p>This mode helps save energy. You can use this mode when you are away from home or outside the room where the thermostat is located.</p> <p>The temperature setpoint maintained under this mode is the same with that scheduled in Unoccupied mode using the mobile app. Deactivation of this mode switches the thermostat to the scheduler you've set (if you haven't set one, the thermostat works following a default scheduler).</p>
OFF	<p>Depending on how you've set up the thermostat, this mode can mean one of the following:</p> <ul style="list-style-type: none"> Your heating equipment turns off completely. Your thermostat only works to maintain the system's protection setpoint so that your heating equipment is not destroyed if the room air temperature is too low, or if the air is too humidified or dry. For more information about the protection setpoint, see Managing application settings [→ 28]. <p>Deactivation of this mode switches the thermostat to the scheduler you've set (if you haven't set one, the thermostat follows a default scheduler).</p>

Switch to the OFF mode

- On the Home screen, tap , and then tap **OFF** on the **Operation Mode** page.

NOTE: To awake your thermostat from the **OFF** mode, tap the screen.

Change the thermostat behavior under the OFF mode

- On the Home screen, tap , then tap  and .
- If prompted, enter the administrator password.
- Tap  > , and then tap **Off/protection configuration**.
- Tap either **OFF** or **Protection**.

Switch between At home and AWAY modes

- On the Home screen, tap  to switch from **At home** to **AWAY**.
- Tap  to switch from **AWAY** to **At home**.

6.2.2 Operating modes in a scheduler

Operating mode overview

Operating mode	Description
Comfort	Makes you feel comfortable when you are at home or inside the room where the thermostat is located.
Economy	Makes you feel comfortable when you are asleep. It also helps save energy.
Unoccupied	Save energy when you are away from home or outside the room where the thermostat is located.

These operating modes are different in terms of temperature setpoints, humidification setpoints and dehumidification setpoints. You can adjust these setpoints for different operating modes under **Advanced Settings > Optimization**. Unlike the humidification setpoint or dehumidification setpoint, you can temporarily adjust the temperature setpoint directly from the thermostat home screen or using the mobile app.

You can only see and schedule these operating modes in a mobile app. However, on the hardware unit, you can switch the thermostat to operate automatically following a scheduler. When a scheduler is running, the above modes operate as scheduled within different periods of a day (If you haven't set one, the thermostat works following a default scheduler). If you've changed a temperature setpoint when a scheduler is running, your change only works temporarily within the current scheduled mode and will be overridden to the scheduled settings when the next scheduled mode starts. You can see the overriding information on both the thermostat screen and app screen.

NOTE: See Setting schedulers [→ 47] for more details about scheduling.

Switch the thermostat to work following a scheduler

- On the Home screen, tap  if  is not displayed on the screen.







NOTE: Unlike when a scheduler is running, all your changes work permanently if  is toggled on.



6.3 WLAN connection

Connecting to a WLAN network allows you to connect to the cloud server and control your thermostat from a smartphone. Depending on how you've set the thermostat to connect to the Internet, you must go to **Advanced Settings** or **Settings** to manage the WLAN connection:

- If you've selected **Private WLAN** (home use), go to **Settings**.
- If you've selected **Administrated WLAN *** (commercial use), go to **Advanced Settings**.





Connect to a network

1. If the thermostat is selected for commercial use, do the following:
 - On the Home screen, tap , then tap . The **Advanced Settings** page displays.
 - If required, enter your administrator password.
 - Tap  > , and then wait for the thermostat to discover the networks nearby.
2. If the thermostat is selected for home use, do the following:
 - On the Home screen, tap , and then tap  until the **Settings** page displays.





- Tap  > , and then wait for the thermostat to discover the networks nearby.
- 3. Tap your desired network. If necessary, tap ▼ or ▲ to scroll through the networks to select one.
- 4. For secured networks, enter the relevant password, and then tap **Connect**.

Note: For more information about the administrator password, see Creating an administrator password [→ 25].

Manually add a network

1. If the thermostat is selected for commercial use:
 - On the **Advanced Settings** page, tap  > , and then tap ▼ to scroll down to find and tap **Add Network**.
2. If the thermostat is selected for home use:
 - On the **Settings** page, tap  > , and then tap ▼ to scroll down to find and tap **Add Network**.
3. Enter the Network name (SSID) information.
4. To select a security type, tap the **Security** field.
5. Tap **Connect**.
6. If prompted, enter the relevant password, and then tap **Connect**.



Configure your current network settings





1. If the thermostat is selected for commercial use:
 - On the **Advanced Settings** page, tap  > . Your current network displays on the screen.
2. If the thermostat is selected for home use:
 - On the **Settings** page, tap  > . Your current network displays on the screen.
3. Tap **Network Settings**. The default DHCP (Dynamic host configuration protocol) setting page displays on the screen.
 - If necessary, tap ▼ or ▲ to scroll through and view other network DHCP settings like **Preferred DNS**.
 - If you want to customize the current network settings, tap **Manual**, select a field, or tap ▼ or ▲ to scroll to the desired field, and then enter a new setting.

Connect to a network via push button

If you have little knowledge about wireless security, using the push button method makes it easy for you to establish a secure wireless network connection. If you want to use this method, you must have a WPS (Wi-Fi Protected Setup) compatible router.

Connect to a network using the push button

1. If the thermostat is selected for commercial use:
 - On the **Advanced Settings** page, tap  > , then tap ▼ until you see **Push Button Setup**.
2. If the thermostat is selected for home use:

- On the **Settings** page, tap  > , then tap  until you see **Push Button Setup**.
- 3. Tap **Push Button Setup**, and then press the WPS button on your WPS-supported router to start the discovery of your thermostat.
- 4. On the thermostat, tap  > **Connect**.
- 5. Tap **OK** once the thermostat is connected to the network successfully.





6.4 Screen lock protection

6.4.1 Locking the home screen

Whether the thermostat is selected for commercial or home use, you can set a numeric screen code to lock the home screen and protect the thermostat from misuse.

Apart from using the screen code to unlock the screen, you can also use an administrator password (if you've set one) to unlock the screen.

Create a screen lock code



1. On the Home screen, tap , then tap .
2. Tap  >  > **Activate**. Enter a code consisting of six numbers, and then tap **OK**.
3. Tap **OK** again to confirm.

Unlock the home screen



- On the Home screen, enter the screen lock code directly and then tap **OK**.
- If you've set an administration password, tap the question mark on the screen, and then tap **Log in as administrator**.

NOTE: There is no limit of attempts to enter the numeric code. If you cannot remember the screen lock code, you can use the administrator password (if you've set one) to unlock the screen. For more information, see [What should I do if I forget the screen lock code? \[→ 51\]](#)

Modify screen lock password

1. On the **Settings** page, tap .
2. Tap  > **Change**, specify a new numeric lock of six numbers, and then tap **OK**.
3. Tap **OK** to confirm.

Remove screen lock password

1. On the **Settings** page, tap .
2. Tap  > **Deactivate**, then tap **OK** to confirm.

6.4.2 Creating an administrator password

	NOTICE
	If your thermostat is selected for home use, it is recommended that you don't create an administrator password because there is no way to change it to a new password if you've lost or cannot remember it. If you've created a password but lost it, contact the product supplier or the agency for support.

If your thermostat is selected for commercial use, setting an administrator password can help you prevent unauthorized access to **Advanced Settings** if it is installed in a public place. You can create the password in the setup wizard when you use your thermostat for the first time. You can also create, modify or deactivate it later under **Advanced Settings**.

Actions protected by the administrator password are listed as below. You can find them under **Advanced Settings** as well.





- Checking the basic information about the thermostat.
- Viewing/Using the activation code of the thermostat.
- Changing or deactivating the administrator password.
- Setting up WLAN connection.
- Changing date and time.
- Changing application settings.
- Changing basic/extended configurations and doing factory resets.

If you cannot remember the created administrator password, turn to the product supplier or agency for support.



If your thermostat is selected for home use, options related to WLAN connection is accessible from **Settings** instead of **Advanced Settings**.

Create/activate an administrator password under Advanced Settings

1. On the Home screen, tap , then tap . The **Advanced Settings** page displays.
2. Tap  > **Password** > **Activate**.
3. View the password policy on the screen, and then tap .
4. Enter a strong password required by the password policy, and then tap **OK**.
5. Tap **OK**.



Manage your administrator password

1. On the **Advanced Settings** page, tap  > **Password**.
2. Modify or deactivate the administrator password.

6.5 Turning on/off the supply of domestic hot water

Use your thermostat to manage the supply of DHW (Domestic Hot Water) if corresponding external equipment is connected with your thermostat and you've also configured the thermostat output as a domestic hot water boiler. You can turn on or off the supply of domestic hot water, or let the thermostat automatically adjust whether and when to turn it on.

Turn on/off the supply of domestic hot water

1. On the Home screen, tap , then tap > > .
2. Tap either **ON**, **OFF** or **AUTO**.

6.6 Basic settings

Under basic settings, you can:

- Lock/Unlock the home screen [[→ 25](#)]
- Change the temperature unit [[→ 21](#)]
- Connect to a WLAN network [[→ 23](#)] if the thermostat is selected for home use





- Turn on/off the touch sound
- Change the display language
- Specify a room name

The first three options are described in separate sections. This section only describes the last three options.

6.6.1 Turning on/off the touch sound



You can adjust whether the thermostat responds to your touching actions with sounds.

Turn on/off the touch sound

1. On the Home screen, tap , then tap > until the **Settings** page displays.
2. Tap , and then tap  or  to turn on or off the touch sound.

6.6.2 Changing the display language



Change the display language

1. On the **Settings** page, tap  > .
2. Tap the new language that you want to change to. If necessary, tap ▼ to scroll to the desired language.

6.6.3 Naming a room

You can give a unique name to a room where your thermostat is installed. Doing so helps you easily recognize the room when you are remotely controlling the thermostat.

Name a room

1. On the **Settings** page, tap  > .
2. Tap the text field, and then enter a room name as desired, or tap ▼ to select a name from the pre-set list.
3. Tap **OK** once you've entered the room name.

6.7 Advanced settings

NOTE: It is recommended that only installers or experts with detailed know-how about the thermostat change advanced settings.

Under Advanced settings, you can:









- Manage the administrator password [→ 25]
- Connect to a WLAN network [→ 23] if the thermostat is selected for commercial use
- Scan the QR code of the activation code [→ 41]
- Change a time zone
- Adjust different application settings
- Re-set up the thermostat
- Check the basic information about your thermostat

The first three options are described in separate sections. This section describes the remaining options.

6.7.1 Changing a time zone

When there is internet connection, the thermostat automatically detects the time zone for you. However, you can also change it manually.

Change the time zone

1. On the Home screen, tap , then tap  and .
2. If prompted, enter the administrator password.
3. Tap  >  > **Adapt**, and then select an area on the map.
4. Tap  or  to scroll to a desired time zone, tap to select it and then tap .
5. If it is connecting to the cloud, the thermostat detects the date and time automatically for you based on your previously-selected time zone. If it is not connecting to the cloud, follow the on-screen instructions to set the year, month and date manually.

6.7.2 Managing application settings

You can manage application settings by turning on/off a specific function or change setting values. It is strongly recommended that only installers or experts with detailed know-how about the thermostat modify the application settings.

NOTE:

- Parameter availability depends on your selected application for your thermostat.
- Numbers marked in the above table are only for easy readability in this document. They don't represent the parameter numbers in the local hardware unit.

Multi-functional inputs

No.	Application settings	Descriptions	Factory settings	Range	Dependencies
1.	X1 room temp. ref. at 0V	Room temperature at 0 V of the 0-10 V input in terminal X1	0 °C	-50...80 °C	A DC 0...10 V external room temperature sensor must be connected with the thermostat using terminal X1.
2.	X1 room temp. ref. at 10V	Room temperature at 10 V of the 0-10 V input in terminal X1	50 °C	-50...80 °C	
3.	X2 room temp. ref. at 0V	Room temperature at 0 V of the 0-10 V input in terminal X2	0 °C	-50...80 °C	A DC 0...10 V external room temperature sensor must be connected with the thermostat using terminal X2.
4.	X2 room temp. ref. at 10V	Room temperature at 10 V of the 0-10 V input in terminal X2	50 °C	-50...80 °C	
5.	Outside temp. ref. at 0V	Outside air temperature at 0 V of the 0-10 V input	-50 °C	-50...80 °C	A DC 0...10 V external outside air temperature sensor must be connected.
6.	Outside temp. ref. at 10V	Outside air temperature at 10 V of the 0-10 V input	80 °C	-50...80 °C	

No.	Application settings	Descriptions	Factory settings	Range	Dependencies
7.	X1 floor temp. ref. at 0V	Floor temperature at 0 V of the 0-10 V input in terminal X1	-50 °C	-50...80 °C	A DC 0...10 V external floor temperature sensor must be connected using terminal X1.
8.	X1 floor temp. ref. at 10V	Floor temperature at 10 V of the 0-10 V input in terminal X1	80 °C	-50...80 °C	
9.	X2 floor temp. ref. at 0V	Floor temperature at 0 V of the 0-10 V input in terminal X2	-50 °C	-50...80 °C	A DC 0...10 V external floor temperature sensor must be connected using terminal X2.
10.	X2 floor temp. ref. at 10V	Floor temperature at 10 V of the 0-10 V input in terminal X2	80 °C	-50...80 °C	

Heating setpoints

No.	Application settings	Descriptions	Factory settings	Range	Dependencies
11.	Comfort heating setpoint	The default heating setpoint for Comfort defined in a scheduler. This setpoint must be higher than that for protection.	21 °C	0...50 °C	N/A
12.	Economy heating setpoint	The default heating setpoint for Economy defined in a scheduler. This setpoint must be higher than that for protection.	19 °C	0...50 °C	N/A
13.	Unoccupied heating setpoint	The default heating setpoint for Unoccupied mode. This setpoint must be higher than that for protection.	15 °C	0...50 °C	N/A
14.	Protection heating setpoint	The default minimum heating setpoint to maintain when you switch the thermostat to OFF under  > Operation Mode .	7°C	0...50 °C	This setpoint is valid only if you keep the default Protection option for Application setting No. 37.
15.	Max. heating setpoint	The default maximum heating setpoint if the thermostat is not switched to OFF . If it is OFF , the maximum heating setpoint is then the heating protection setpoint.	35°C	0...50 °C	The heating protection setpoint is valid only if you keep the default Protection option for Application setting No. 37.

Humidification setpoints

No.	Application settings	Descriptions	Factory settings	Range	Dependencies
16.	Comfort humidity setpoint	The humidification setpoint for Comfort . This setpoint must be higher than the humidification setpoint for protection.	40%RH	0...100%RH	Displays only if you've configured the output as Humidifier (no fan) .
17.	Economy humidity setpoint	The humidification setpoint for Economy . This setpoint must be higher than the humidification setpoint for protection.	40%RH	0...100%RH	
18.	Unoccupied humidity setpoint	The humidification setpoint for Unoccupied . This setpoint must be higher than the humidification setpoint for protection.	30%RH	0...100%RH	
19.	Protection humidity setpoint	The humidification setpoint to maintain when you switch the thermostat to OFF under ☰ > Operation Mode . This setpoint must be lower than the dehumidification setpoint for protection.	30%RH	0...100%RH	This setting displays only if you've configured the output as Humidifier (no fan) . This setpoint is valid only if you keep the default Protection option for Application setting No. 37.

NOTE: Humidification control works with a PID algorithm. The algorithm continuously monitors the difference between the humidity setpoint for humidification and the measured relative air humidity in the room and switches the humidifier ON and OFF to keep the humidity above the setpoint. The humidifier cannot manually be switched on and off. Changes to the setpoint impact humidification control, thereby verifying functionality.

Dehumidification setpoints

No.	Application settings	Descriptions	Factory settings	Range	Dependencies
20.	Comfort dehum. setpoint	The dehumidification setpoint for Comfort . This setpoint must be lower than the dehumidification setpoint for protection.	60%RH	0...100%RH	Displays only if you've configured the output as Dehumidifier (no fan) .
21.	Economy dehum. setpoint	The dehumidification setpoint for Economy . This setpoint must be lower than the dehumidification setpoint for protection.	60%RH	0...100%RH	
22.	Unoccupied dehum. setpoint	The dehumidification setpoint for Unoccupied . This setpoint must be lower than the dehumidification setpoint for protection.	70%RH	0...100%RH	
23.	Protection dehum. setpoint	The dehumidification setpoint to maintain when you switch the thermostat to OFF under ☰ > Operation Mode . This setpoint must be lower than the dehumidification setpoint for protection.	70%RH	0...100%RH	This setting displays only if you've configured the output as Dehumidifier (no fan) . This setpoint is valid only if you keep the default Protection option for Application setting No. 37.

NOTE: Dehumidification control works with a PID algorithm. The algorithm continuously monitors the difference between the humidity setpoint for dehumidification and the measured relative air humidity in the room and switches the dehumidifier ON and OFF to keep the room humidity below the setpoint. The dehumidifier cannot manually be switched on and off. Changes to the setpoint impact dehumidification control, thereby verifying functionality.

Functions

No.	Application settings	Descriptions	Factory settings	Range	Dependencies
24.	Pump/valve kick cycle	A circle kicked in to turn on a constantly idle pump or valve for a minimum period of time to protect the pump or valve from being locked up. You can set the kick-in time interval by yourself; however, the minimum time period the pump or valve is switched ON depends on what heating controllers setting you've selected.	500 h	1...8760 h	Application setting No. 38; This function displays only if you select the equipment type as one of the following in Changing system setup [→ 36]: Radiator with valve, Radiator with pump, Floor heating with valve or Floor heating with pump.
25.	Room presence detector	Allows switching to Comfort automatically if an unoccupied room is detected to be occupied when a scheduled Unoccupied mode is running.	Active	N/A	N/A

Temperature offsets

No.	Application settings	Descriptions	Factory settings	Range	Dependencies
26.	Built-in temp. sensor adj.	Temperature offset value for the built-in room temperature sensor.	0 K	-5...5 K	Valid only if the built-in temperature sensor is used to measure the temperature.
27.	X1 temp. sensor adj.	Temperature offset value for the room temperature sensor connected in terminal X1.	0 K	-5...5 K	Valid only if an external room temperature sensor is connected using X1.
28.	X2 temp. sensor adj.	Temperature offset value for the room temperature sensor connected in terminal X2.	0 K	-5...5 K	Valid only if an external room temperature sensor is connected using X2.

Minimum switchover time adjustment







No.	Application settings	Descriptions	Factory settings	Range	Dependencies
29.	Humidify (no fan) min. ON time	The minimum working time of a standalone humidifier. This minimum limitation protects the humidifier from being destroyed by frequent switchovers.	3 min	0...60 min	You've configured the thermostat output as Humidifier (no fan) in Changing system setup [→ 36].
30.	Humidify (no fan) min. OFF time	The minimum OFF time of a standalone humidifier. This minimum limitation protects the humidifier from being destroyed by frequent switchovers.	3 min	0...60 min	
31.	Dehum. (no fan) min. ON time	The minimum working time of a standalone dehumidifier. This minimum limitation protects the dehumidifier from being destroyed by frequent switchovers.	3 min	0...60 min	You've configured the thermostat output as Dehumidifier (no fan) in Changing system setup [→ 36].
32.	Dehum. (no fan) min. OFF time	The minimum OFF time of a standalone dehumidifier. This minimum limitation protects the dehumidifier from being destroyed by frequent switchovers.	3 min	0...60 min	
33.	DHW min. ON time	The minimum working time of the domestic hot water boiler. This minimum limitation protects the boiler from being destroyed by frequent switchovers.	3 min	0...60 min	You've configured the thermostat output as Domestic hot water boiler in Changing system setup [→ 36].
34.	DHW min. OFF time	The minimum OFF time of the domestic hot water boiler. This minimum limitation protects the boiler from being destroyed by frequent switchovers.	3 min	0...60 min	

Other settings

No.	Application settings	Descriptions	Factory settings	Range	Dependencies
35.	Heating device electrical load	The electrical load of your connected heating device. It is recommended to enter the real electrical load of your heating device. Otherwise the temperature offset algorithm at the background may not be accurate.	0 A (2 A if you've selected the equipment type as Electric floor heating, Fan with electric heating or Electric radiator.	0...5 A	
36.	Q22/Q24 electrical load	The electrical load of connected outputs	2 A	0...5 A	Displays only if you've configured an output.
37.	Off/protection configuration	Configures whether the thermostat goes to the protection mode or completely turns off in OFF mode.	Protection	Off Protection	N/A

No.	Application settings	Descriptions	Factory settings	Range	Dependencies
38.	Heating control loop	Indicates a different time for PWM (Pulse Width Modulation) pulse periods. You can select the default setting to let the system configure the most suitable heating controller settings based on your selected equipment type.	Default	Slow Medium Default Fast 2-position Self-adaptive	N/A
39.	Floor temperature limit	Floor temperature limit for electric floor heating	40 °C	35...60 °C	Valid only if you've selected the equipment type as Electric floor heating and enabled the floor temperature input in Changing system setup [→ 36].
40.	Optimum start control	Pre-heats the room in an optimum way so that you can get the scheduled temperature setpoint at your scheduled occupied time. You can choose Warm-up gradient to manually define the warm-up speed, or choose Self-adaptive to let the thermostat learn and decide the warm-up speed.	Warm-up gradient	Warm-up gradient Self-adaptive	Visible only if you've activated the optimum start control settings in Changing system setup [→ 36].
41.	Warm-up gradient	The warm-up speed that you set to pre-heat the room.	30 min/K	0...120 min/K	Valid only if you've activated the optimum start control settings in Changing system setup [→ 36] and selected Warm-up gradient for Application setting No.40

Manage application settings

1. On the Home screen, tap , then tap  and .
2. If prompted, enter the administrator password.
3. Tap   , and then scroll to the specific setting that you want to turn on/off or change to a desired Value.
4. Tap to change the setting as desired.

6.7.3 Changing system setup

If you want to change any of your initial setup options that you've already configured during the startup wizard, you can change them later under **Advanced Settings**. You can also change some other default system setup options to suit your own needs. However, we recommend that only installers or experts with detailed know-how about your thermostat modify the setup options.







Changing basic configurations

Changing basic configurations of the thermostat allows you to change the equipment type that your thermostat is working together with. The equipment could be one of the following:

- Gas boiler
- Radiator with valve
- Radiator with pump
- Electric floor heating
- Fan with electric heating
- Floor heating with valve
- Floor heating with pump
- Electric radiator
- Electric boiler
- Generic heating device

If the selected equipment is related to a pump or valve, you can decide whether to run the pump or valve periodically.

Change basic configuration

1. On the Home screen, tap , then tap  and .
2. If prompted, enter the administrator password.
3. Tap   .
4. Tap **OK** to stop all of your thermostat's applications. Your thermostat restarts.
5. After the restart is completed, tap **Equipment > Adapt**.
6. If necessary, tap  to scroll through all the listed equipment types and then choose one as desired.
7. If the equipment is a pump or valve, choose whether to run the pump or valve periodically by dragging the slider on the screen.

Changing extended configurations

By changing extended configurations, you can:

- Change input assignments. Before you configure or change to another input, it is strongly recommended that you've connected corresponding peripheral devices to terminal X1 or X2. The input can be:
 - Room temperature
 - Operating mode switch

The thermostat switches to the **OFF** mode if you've configured the input as **Normally open**. For example, if a thermostat in a hotel is configured to

Normally open for this input, when a hotel guest pulls out the room card, it activates **Normally open**. The thermostat switches to the **OFF** mode. Once the room card is inserted again, the thermostat restarts the previously running mode.



If X1 or X2 were assigned as **Operating mode switch** and the input configured as **Normally open** but physically terminal X1/X2 is not connected to the related field devices, the thermostat may switch to the **OFF** mode and no longer functions normally unless changed to another input.

- Universal contact
 - Floor temperature. This input is selectable only if you've configured the equipment type as **Electric floor heating**.
 - Outside air temperature
 - Room air humidity
 - Presence detector
 - Condensation monitor. If you've configured a condensation monitor as an input, the condensation monitor detects the relative humidity in the room. You will receive a notification on the mobile app if the condensation monitor detects upcoming condensation.
 - Change input signal types based on the input type you've assigned. The following signal types are supported:

NOTICE! If you haven't configured the corresponding application, some inputs may not be selectable.

 - Digital input, normally open or closed
 - LG-Ni1000
 - Pt1000 (EU)
 - Pt1000 (NA)
 - NTC 10k
 - 0...10 V*
 - Set sensor evaluation mode if an external sensor is connected to either terminal X1 or X2. You can use either the built-in and external sensors, or the external sensors, for controlling and monitoring. The former is selected by default. However, if no physical external sensors are connected to any control inputs or if the input values are invalid, only the built-in sensors are used instead to provide values for the thermostat. If external sensors are connected and can provide valid values with the built-in sensors, the thermostat reacts differently depending on the type of the external sensor:
 - Displays the average value if it is an external temperature or humidity sensor.
 - Enable presence detection related functions no matter whether it is the external or the built-in presence detection sensor detects that someone is in the room.
 - If you've configured the equipment type as **Electric floor heating**, choose to activate or deactivate the floor temperature input.
 - Configure the output as a humidifier free-standing, a dehumidifier free-standing or a domestic hot water boiler.
 - Activate or deactivate the optimum start settings for heating. Activating the optimum start settings allows the room to be pre-heated so that you can get the scheduled temperature setpoint at your scheduled occupied time.
- *) If you've selected 0...10 V as the signal type, you must connect a DC 0..10 V active sensor with the thermostat. Otherwise, the calculated value may not be accurate.



Change extended configurations

1. On the **Advanced Settings** page, tap .
2. If prompted, enter the administrator password.
3. Tap **► > **.
4. Tap **OK** to stop all the thermostat's applications. The thermostat restarts.
5. After the restart is completed, tap **I/O > Adapt**.
6. Change the settings as desired.

Resetting the thermostat

You can reset the thermostat to its original factory settings. However, all user data will be erased after the factory resetting.

Factory reset

1. On the **Advanced Settings** page, tap .
2. If prompted, enter the administrator password.
3. Tap **► > **.
4. Tap **OK** to stop all of your thermostat's applications. Your thermostat restarts.
5. After the restart is completed, tap **Factory Reset**.
6. Tap **Reset**. The thermostat is reset and restarted.





NOTE: After the thermostat is restarted, the setup wizard appears for easy commissioning. Refer to the [Quick guide](#) for the detailed setup information.

6.7.4 Checking the basic information about your thermostat

You can check the following information about your thermostat:

- Model name
- Activation code and serial number of the thermostat
- Software and hardware version
- MAC and IP address
- Application used in the thermostat

Check the basic information about your thermostat

1. On the Home screen, tap , then tap **<** and .
2. If prompted, enter the administrator password.
3. Tap  **>** . Detailed information about your thermostat displays.

6.8 Software updates

The thermostat receives updates to get the latest functionality, enhancements and bug fixes so that it has optimal performance. Normally, the updates occur automatically through WLAN connection. It works in the background and doesn't affect your normal usage on the thermostat.

NOTE: During software updates, the system reboot(s) occurs automatically, however, no previous settings are changed.



7 Green leaf indication

The Green leaf indication informs the user that the system has an energy-optimized operation. When the heating output is energized, if the thermostat detects that the room air temperature is 2 K higher than the default heating setpoint for **Comfort** or **Economy**, the leaf icon turns to red. Touch the red leaf to switch the setting back to an energy-optimized operation:

- Control the temperature according to Green Leaf default setpoints for heating.
- Operate an actuator, boiler or compressor automatically based on a scheduler.
- Switch to follow a scheduler with a pre-set setpoint that you've defined under **Advanced Settings > Optimization**.

8 Air quality display

By using a built-in VOC (Volatile Organic Compounds) sensor, your thermostat measures the room air quality and shows the air quality status symbol on the local idle screen. In the mobile app, the status is indicated by text instead.

Symbol on the local idle screen	Text in the mobile app	Description	VOC level [% of the output range]
	Good	The room air quality is good	<50%
	Okay	The room air quality is okay	50% ~ 80%
	Poor	The room air quality is poor	>80%



In order to ensure that the room air quality is measured accurately when the room is closed for a long time, it is recommended to force air circulation such as opening a window.

9 Operating the thermostat from the mobile app

9.1 Downloading the app

To control the thermostat remotely, download the **Siemens Smart Thermostat RDS** app from Google Play or App Store.

Download app

1. Open Google Play or App Store, and then search for **Siemens Smart Thermostat RDS**.
2. In the searched result page, tap the item to view its details, then follow the instructions to complete the installation.







9.2 Account creation and pairing

Once the app has been downloaded, create an account and then associate the account with the thermostat(s). Functions possible then are:

- Remote control – Control the thermostat remotely. Other users can also use the created account to control the thermostat(s).
- Account administration – Manage the user account remotely such as changing/resetting password and adding/removing devices.

Create an account in the app and associate it with the thermostat(s)

▷ The thermostat is connected to a network.

1. Open the app in your smartphone.
2. Enter a valid email address.
3. On the local thermostat, do one of the following:
 - On the Home screen of the thermostat, tap  and , and then tap  and . The activation code and the QR code will display.
 - If  is available on the Home screen, tap it and then tap . The activation code and the QR code will display.
4. In the app, scan the QR code using the built-in scanner or enter the activation code manually.
5. Agree to the terms of use, and then tap **Create**. You will receive a confirmation email.
6. Enter the code enclosed in the confirmation email, set a password for the account, then tap **Activate**.
7. To associate additional thermostats with the account, tap  > **Devices** > **Add Device** and then add devices by scanning the corresponding QR codes.



After initial power up of the thermostat and after initial system configuration, tap  to create an account and associate mobile app. Refer to the [quick guide](#) for more detailed information.



If you reconfigure the local thermostat, you must log out and back into the app before the new changes take effect.

Manage account information in the app

1. In the app, tap \equiv > **Account**.
2. Manage your account information. For example, change the user name, modify the password, or choose another display language.

9.3 Changing background color

You can change the mobile app's background color from dark to light or vice versa as you like.

Change the theme color

1. In the app, tap \equiv > **Account**.
2. Expand the **Theme** field, and select any background color.

9.4 Managing the information about your thermostat remotely

Once a thermostat is added to the mobile app, you can view its detailed information such as its current connection status (online, offline or upgrading), modify a room name and remove a device.

The device's connection status

Online	The thermostat is connecting to the cloud server.
Offline	<p>The thermostat is not connecting to the cloud server. Several reasons may lead to such disconnection:</p> <ul style="list-style-type: none"> • The thermostat is powered off. • The thermostat is not connected to the internet. <p>When a device is offline, you can only perform the following operations:</p> <ul style="list-style-type: none"> • Sign up, sign in or sign out. • Change and recover a password. • Change user account settings. • Delete device.
Upgrading	The thermostat is upgrading to a new software version.

Managing thermostat details

Change room name

1. Tap \equiv > **Devices**.
2. Select the device that you want to change the room name.
3. Tap the **Room** field, and then enter the new room name.

Delete thermostat

1. Tap \equiv > **Devices**.
2. Select the thermostat that you want to delete.
3. Tap **Remove Device** > **Yes**.

9.5 Widget overview

The remote control platform of the thermostat consists of three widgets: temperature control, domestic hot water and running hours. Swipe to the left or right to switch overs between widgets.

If the thermostat output is not configured as domestic hot water boiler, the domestic hot water widget doesn't display in the app.



The running hours widget displays the heating consumption during a specific period of time. It displays only if heating is enabled.

Access widgets

1. Open the app, and then select a specific location if you've added several devices to your account. An overview of the current status in your location is displayed. If your account is associated with only one thermostat, the system automatically brings you to the temperature control widget page after you've opened the app.
2. If necessary, swipe to the right or left to view all the widgets.

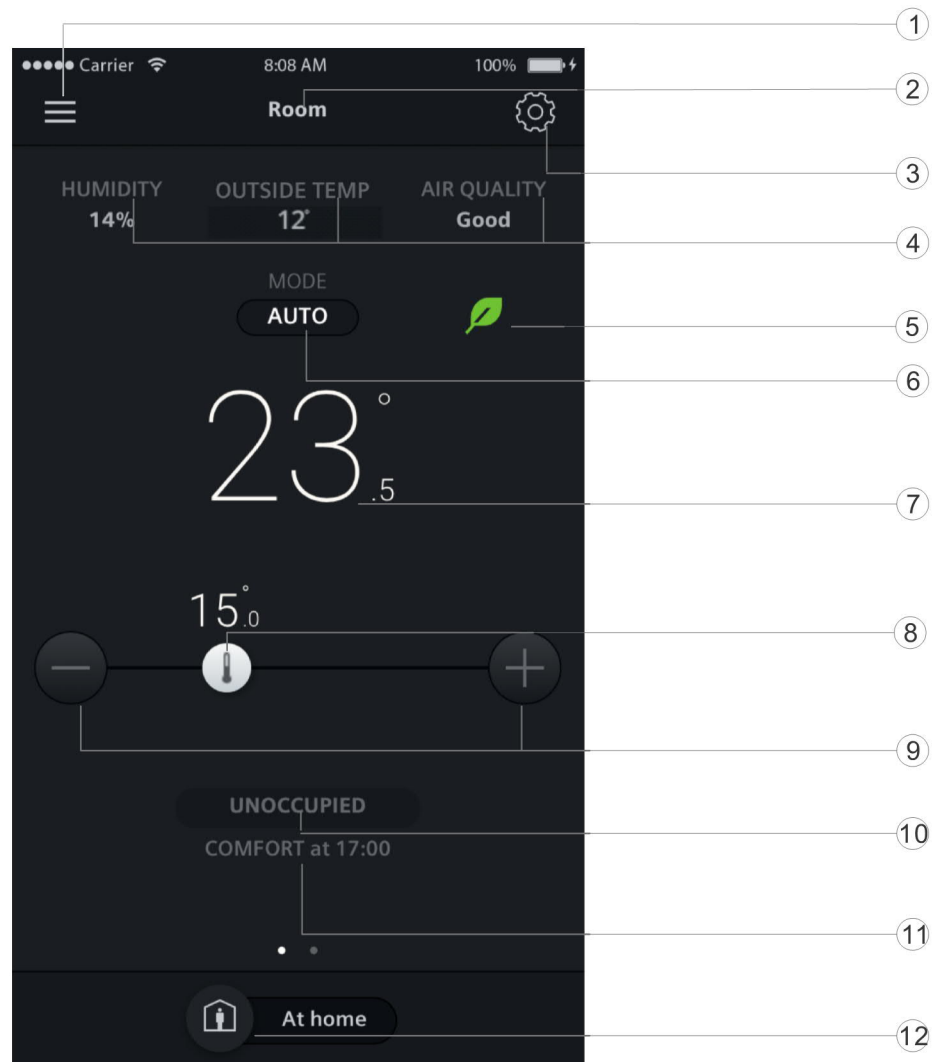
9.5.1 Temperature control widget overview



1	Entry to the Options menu.
2	Displays the room name that you've selected to view and control the thermostat settings.
3	Displays more detailed settings.
4	Displays the room humidity, outside air temperature and air quality.
5	Informs you that the system has an energy-optimized operation. If the thermostat is not running in an energy-saving mode, the leaf icon turns red. Touch the red leaf to switch the setting back to an energy-optimized operation.
6	Displays whether the thermostat is operating following a scheduler or not.  means the scheduler is running, while  means the scheduler is not activated. Tap on the icon area to toggle between the two modes. These two modes are also available on the Home screen of the local hardware unit.
7	Displays the current room temperature.
8	Temperature setpoint slider. Dragging it over the temperature setpoint line can change the temperature setpoint. The temperature setpoint value shown above the line changes accordingly.
9	Tap to decrease or increase the temperature setpoint.
10	Displays the current scheduled operating mode. Only displays when the icon  displays on the same screen. If you've changed the temperature setpoint, information about temporary override displays in this area.
11	Displays the next scheduled operating mode and when it starts.
12	Toggle to switch between At home and AWAY . These two modes are also available on the Home screen of the local hardware unit. For more information about the two modes, see Operating modes with manual switchover [→ 22].

9.5.2 Domestic hot water widget overview

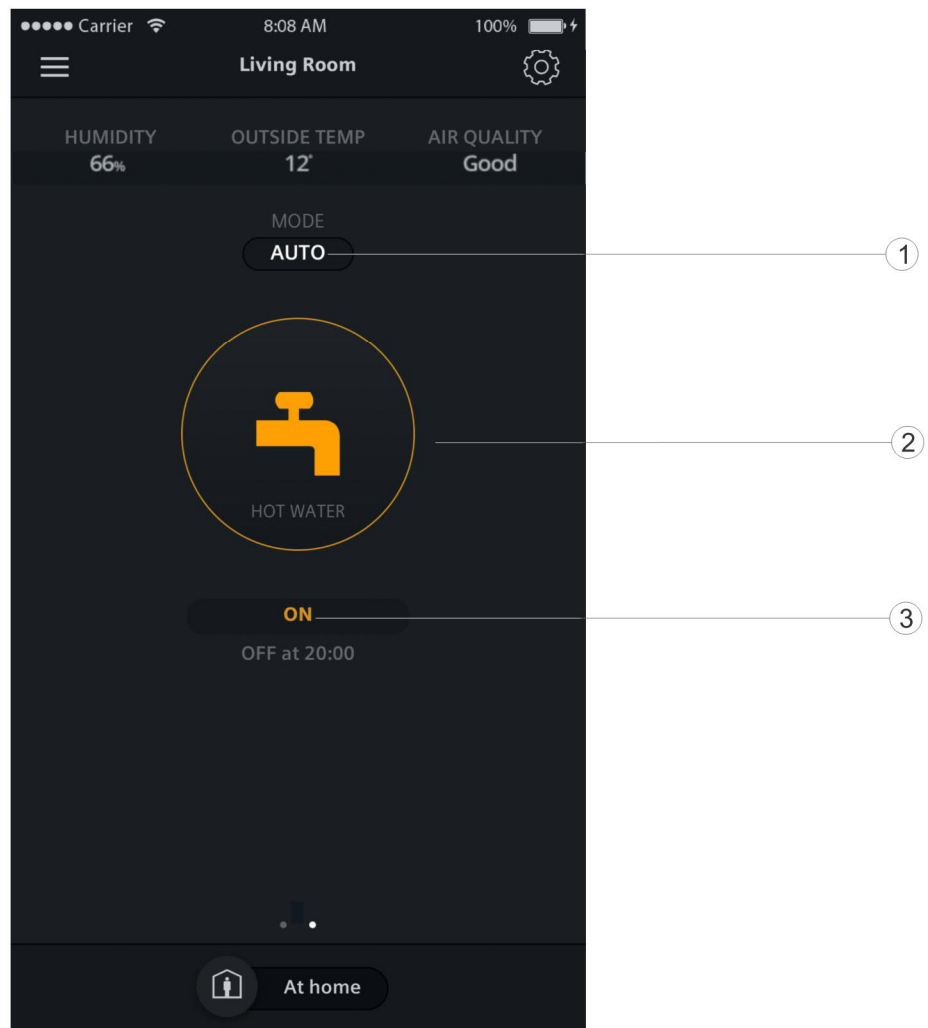

1	Toggle to decide whether to turn on or off the domestic hot water following a scheduler. AUTO means the scheduler is running, while ON means you must manually turn it on or off.
2	Displays whether the domestic hot water is turned on or not. You can toggle the icon to switch from AUTO to ON and then turn on or off the domestic hot water under the manual mode.
3	Displays whether the domestic hot water is currently turned on or off. You can see from the adjacent text when the status will be switched if you've set a scheduler for the supply of the domestic hot water.

NOTE: If you haven't configured the thermostat output as a domestic hot water boiler, the domestic hot water widget doesn't appear in the app.

9.5.3 Running hours widget overview

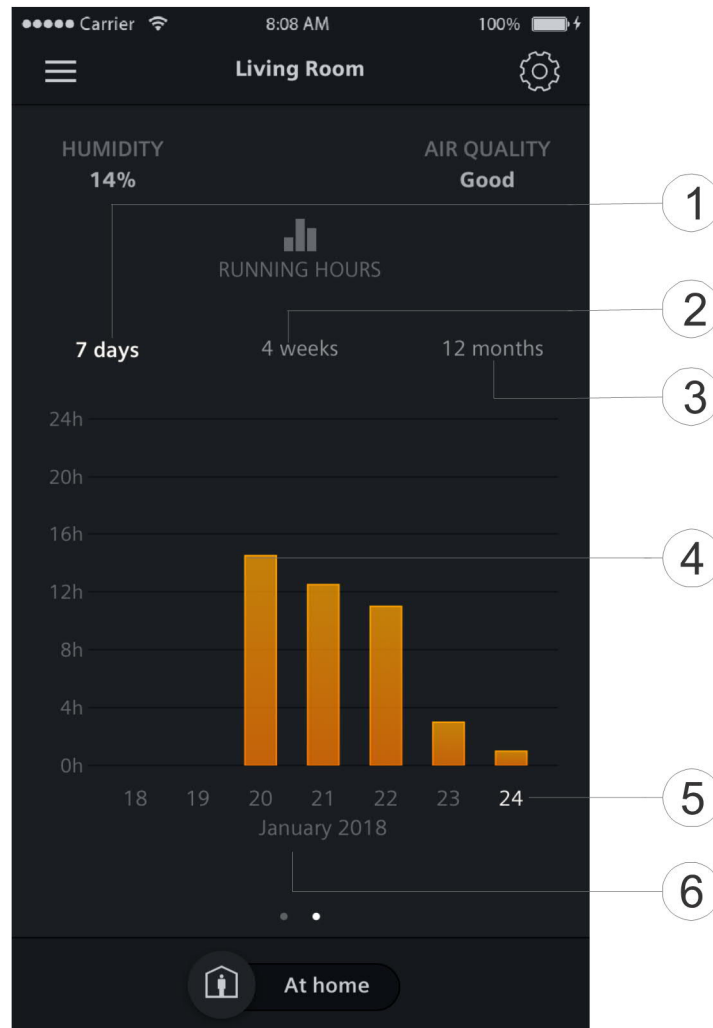

1	Seven-day view by default, showing the heating running hours of each week day counting down from the current day.
2	Tap to switch to the four-week view.
3	Tap to switch to the 12-month view.
4	Indication of heating running hours
5	The current day/month
6	The current month/year

9.6 Temperature control

No matter whether the thermostat is operating following a scheduler or not, you can change the temperature setpoint. If a scheduler is running, your change is effective within the current scheduled mode and will be overridden to the scheduled setpoint when the next scheduled modes starts. If no scheduler is running, your change is always effective unless you make changes again. The temperature value can be in °C or °F. You can change the temperature unit under **Account**.

NOTE: For more information about schedules, see Setting schedulers [→ 47].

Adjust the temperature setpoint

Do one of the following:

- On the temperature control widget, drag the temperature knob over the temperature line as desired.
- Tap the minus or plus icon on the widget.

Change the temperature unit

1. In the app, tap and then tap **Account**.
2. Expand the **Unit** field, and then change the temperature unit.

9.7 Turning on/off the supply of domestic hot water

Turn on/off the domestic hot water manually

1. On the domestic hot water widget, tap to switch to , if is not displayed on the screen.
2. If you want the domestic hot water to be always on, ensure that **ON** displays on the screen. If you want to turn off the domestic hot water, tap the domestic hot water tap icon.

Turn on/off the domestic hot water following a scheduled time

- On the domestic hot water widget, tap to switch to , if is not displayed on the screen. The thermostat then controls the domestic hot water following your scheduler.

NOTE: For more information about schedulers, see Setting schedulers [→ 47].

9.8 Switching between Away and At home

You can set your thermostat to the **AWAY** mode to avoid wasting of energy, or the **At home** mode for a comfortable room temperature.

Switch between AWAY and At home

- Tap **At home** or **AWAY** at the bottom of any widget.

9.9 Setting schedulers

If you've set the thermostat to operate automatically following a scheduler, the scheduler can be the default, or the one you set following your daily schedule.



By default, the thermostat works as follows:

Days	Time periods when Comfort mode is on	Time periods when Unoccupied mode is on
Monday to Friday	6 AM – 8 AM 5 PM – 10 PM	8 AM – 5 PM 10 PM – 6 AM
Saturday to Sunday	7 AM – 10 PM	10 PM – 7 AM

If you want to set your scheduler, you can set different time periods for the following operating modes: **Comfort**, **Economy** and **Unoccupied**. For more information about these operating modes, see Operating modes in a scheduler [→ 23].

If the thermostat is also configured to control the domestic hot water, you can adjust the time period when you want to control the domestic hot water supply. Finishing scheduling for one day allows you to easily copy the schedules to other days. You can also change the preset setpoints for different working modes to meet your needs.

Switch the thermostat to work following a scheduler

- From the Home screen of either the local hardware unit or the mobile app, tap  if  is not displayed on the screen.

Set time periods for different operating modes

1. On the temperature control widget screen, tap  > **Thermostat schedule**.
2. Select which day of the week you want to set schedules for. By default, the system uses the current day.
3. On the vertical time line, tap and hold a specific time point to set a switching point. A switching point marker displays beside the time point. If you want to fine tune the switching point, drag the switching point marker to the desired time.
4. Tap the switching point marker, and then select **Comfort**, **Economy** or **Unoccupied** from the drop down list.
5. Repeat Steps 3 and 4 to set other switching points.

NOTE: You can set a maximum of five switching points per day. If you want to delete one, tap  on the switching point marker.

Set time periods for the supply of domestic hot water

1. Verify that you have set the function to control the supply of domestic hot water.
2. On the domestic hot water widget screen, tap  > **Hot water schedule**.
3. Select which day of the week you want to set schedules for. By default, the system uses the current day.
4. On the vertical time line, tap and hold a specific time point to set a switching point. A switching point marker displays beside the time point. If you want to fine tune the switching point, drag the switching point marker to the desired time.
5. Tap the switching point marker, and then select **ON** or **OFF** from the drop down list.
6. Repeat Steps 3 and 4 to set other switching points.

NOTE: You can set a maximum of five switching points per day. If you want to delete one, tap  on the switching point marker.

Copy one day's scheduler to other days

1. On the temperature control or domestic hot water widget screen (if you've set the function to control the domestic hot water supply), tap .
2. Tap **Thermostat schedule** or **Hot water schedule** as desired.
3. Specify which day's scheduler you want to copy from.
4. Tap **Copy**, and then select which days where you want to copy the scheduler.
5. Tap **Paste**. The scheduler is pasted.

Change the preset setpoints for different operating modes

1. On the temperature control widget screen, tap .
2. Tap any of the working modes, for example, **Unoccupied**, to expand the preset setpoints.
3. Drag the temperature slider to the setpoint as desired. If you've adjusted to a new heating setpoint that is higher than the current room temperature, the system turns on heating.

9.10 Switching between heating and OFF modes

Switch between HEAT and OFF

1. On any of the widget screen, tap , and then expand the drop down list beside **Thermostat mode**.
2. Select **HEAT** or **OFF**.

10 Disassembly and disposal

Your thermostat is designed for maintenance-free operations. Disassembling should only be done after the power supply is off and is only limited to the licensed installers only for disposal purpose. Siemens doesn't guarantee the user's safety if the disassembly process is managed by any unlicensed installers.

Disassembly

- Turn off the power supply and then use a screw driver to pry the front module off from the hole at the top of the thermostat.

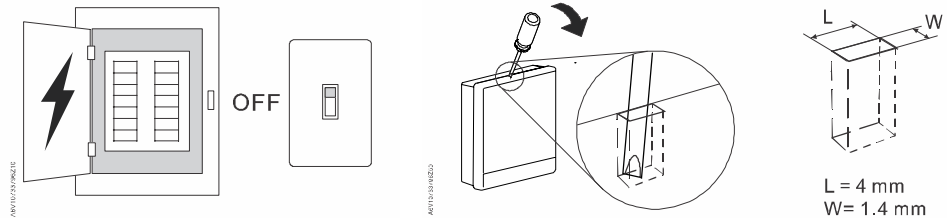

- If needed, disconnect the cables or detach the rear module by unscrewing the screws anticlockwise. Or, if there is decoration frame, detach it as well by unscrewing the screws.

Disposal

	<p>The device is considered an electronic device for disposal in accordance with the European Guidelines and may not be disposed of as domestic garbage.</p> <ul style="list-style-type: none"> • Dispose of the device through channels provided for this purpose. • Comply with all local and currently applicable laws and regulations.
--	--

11 Appendices

11.1 Frequently asked questions

11.1.1 What should I do if I forget the screen lock code?

Try using the administrator password to unlock the screen.

Unlock the screen using the administrator password

1. On the hardware unit screen indicating that the screen lock code is incorrect, tap the question mark > **Login**.
2. Input the administrator password, and then tap **OK**.

11.1.2 What if two users change the same setting at the same time?

The last command received by the server takes effect.

11.1.3 Will the thermostat work if the connection to the cloud is lost?





Yes, the thermostat (hardware unit) works with or without the network connection:

- If there is network connection to the cloud and you've also set your scheduler, the thermostat works following your scheduler. Your temporary change of the temperature setpoint only takes effect during the current scheduled mode.
- If there is network connection but you haven't set a scheduler, the thermostat works following the default scheduler set by the system). For more information about the default scheduler, see [Setting schedulers](#) [→ 47].
- If there is no network connection or valid time, the thermostat cannot get scheduler information from the Cloud. It always works under the **Comfort** mode.

11.1.4 Why does the scheduled Eco mode change to Comfort?

This is probably because the thermostat detects that someone enters into the room when a scheduled **Unoccupied** mode is running. In this case, the thermostat switches from **Unoccupied** to **Comfort** automatically until the next scheduled mode starts. However, you can turn off the auto-switch by disabling the **Room presence detector** parameter under **Advanced Settings**.

Disable the switch from Unoccupied to Comfort even if the room is occupied

1. On the Home screen, tap , tap < and then tap .
2. If prompted, enter the administrator password.
3. Tap , tap , and then tap . Scroll down and tap **Room presence detector**.
4. Drag the slider to the left.

11.1.5 What is the difference between Administrated WLAN and Private WLAN?

Administrated WLAN * is supposed to connect to an infrastructure network managed by facility managers; **Private WLAN** fits for owner cases and is supposed to connect to a home network. Selecting the WLAN connection type differently only affects the entry to WLAN management:

- If you've selected **Administrated WLAN ***, you can only manage WLAN under **Advanced Settings**.
- If you've selected **Private WLAN**, you can manage WLAN under either **Settings** or **Advanced Settings**.

NOTE: In order to differentiate institutional use from home use, this document recommends only **Settings** for home users to manage the WLAN connection.

11.1.6 What if the WLAN network is down during software updates?

Reconnecting to the network resumes the updating process. However, if the network can't be reconnected within a short time and you want the thermostat to work normally during the disconnection period, tap and hold down the warning icon ▲ displayed on the screen for at least ten seconds. You are then directed to the **Setup** page where you can check the previous settings, perform factory resetting or do nothing but return to the normal home screen.

11.1.7 Can I change the Green leaf settings?

No, you can't. The Green leaf settings are defined by the system and are not changeable from user side.

For more information about Green leaf, see Green leaf indication [→ 39].

11.1.8 Can I change the air quality measurement standard?

No, you can't. The thermostat decides the air quality status using the VOC levels that are defined by the system and not changeable from user side.

For more information about air quality, see Air quality display [→ 40].

11.1.9 Where can I check the current time on the thermostat?

You can check the time under **Advanced Settings > Time**.

- If the thermostat has WLAN connection now and hasn't been powered off for more than three minutes, the time is displayed validly and correctly.
- If the thermostat has WLAN connection now but has been powered off for more than three minutes, the time may be displayed invalidly temporarily but will be synchronized with the server within 24 hours. Once the synchronization is done, the time will be displayed correctly again.
- If the thermostat doesn't have WLAN connection now, see more information in this section: Can the thermostat display the time correctly if there is no WLAN connection? [→ 53]

NOTE: To display the time correctly, it is important to set the time zone correctly. See Changing a time zone [→ 28] for more information.

11.1.10 Can the thermostat display the time correctly if there is no WLAN connection?

If there is no WLAN connection, the thermostat displays the time correctly only when:

- The thermostat connected to a WLAN network once and could display time correctly.
- The thermostat hasn't been powered off for more than three minutes.

Lacking either of the above conditions may result in incorrect time display.

11.1.11 Can I set the time manually?

No, you can't. The thermostat gets the time automatically after you've added the thermostat to a WLAN network and set a correct time zone.

11.1.12 Why is the time displayed incorrectly even though the thermostat is added to a WLAN network?

Maybe it is because the synchronization with the server hasn't started yet, or because the time zone is not selected correctly. Normally the server synchronizes the time at a fixed time of each day.

11.1.13 How does the built-in PIR sensor work?

See Presence detection using the built-in PIR sensor [→ 18].

11.1.14 What does the Pump/valve kick function mean?

It means whether to run a constantly idle pump or valve periodically to protect it from seizure. If one of the following equipment is selected as the heating system, **Pump/valve kick** is available and you can decide whether to activate the function or not.

- Radiator with valve
- Radiator with pump
- Floor heating with valve
- Floor heating with pump

For more information about equipment selection and activation of the **Pump/valve kick** function, see Changing system setup [→ 36]. For more information about the interval of running the pump or valve forcibly, see Parameter 24 in Managing application settings [→ 28].

11.1.15 I've registered an account but cannot log in.

Check your email and ensure that you received an activation email. Follow the instructions to activate your account and then log in to the mobile app.

11.1.16 I've signed up but have not received a confirmation email.

Check for the email in your Junk or Deleted folder. If there is no email in the Junk or Deleted folder, request the confirmation email again.

11.1.17 Can I create more than one user account in the mobile app?

Yes, you can, but you cannot log into different accounts at the same time. Besides, it is normally unnecessary to do so if you want to manage more than one thermostat using the app, because one user account can associate with a maximum of 12 thermostats. However, one thermostat can only be associated with one user account. If your family members or colleagues want to manage the thermostats, you can share the account info with them.

See Account creation and pairing [→ 41] for more information about account creation.

11.1.18 What should I do if I forget my account's password?

You must reset the password following the on-screen instructions in the app.

11.1.19 How long are date and time valid, if power fails and the thermostat has no connection to the cloud?

If the power fails and thermostat powers up within five minutes, date and time are correct. Following power failure and thermostat restart after five or more minutes, time is displayed only after synchronization is completed. The date is displayed as normal.

The date and time will be synchronized automatically once power is resumed and internet is connected.

11.1.20 How does Optimum start control work?

With **Optimum start control**, the thermostat determines when to preheat the room as per room temperature and scheduled temperature setpoint.

Optimum start control can be influenced by entering **Warm-up gradient** to define warm-up speed. For example, the factory setting of **Warm-up gradient** is 30 min/K. When the room temperature is 1 °C lower than the setpoint, thermostat will start pre-heating the room 30 minutes earlier.

See Managing application settings [→ 28] for more information about **Optimum start control** and **Warm-up gradient**.

11.1.21 How does Adaptive gain control work?

With adaptive gain control, the thermostat automatically adjusts the gain to a better PID algorithm control value based on room temperature and temperature setpoint.

The gain cannot be manually changed.

11.1.22 How long are settings saved in the thermostat if power fails?

User settings on the thermostat are not affected by power failure and remain until users change the original settings.

11.1.23 How does self-heating compensation work?

Self-heating compensation includes two parts: self-heating compensation for relay and device self-heating compensation. Compensation works from the time the device is powered on.

Self-heating compensation for relay can be affected by changes to the load current of the relay. But the device self-heating compensation cannot be directly influenced by user.

11.1.24 How does the thermostat adapt start optimization of outside temperature?

The outside temperature is not involved with logical operation.

11.1.25 How does the temperature switching differential work?

The temperature switching differential can be controlled by PID algorithm and **2-position**. You can check the option under **Advanced Settings> Optimization> Heating control loop**.

The differential is controlled by PID algorithm based on heating request.

The differential is controlled by **2-position**. The hysteresis value is 0.5 °C. When the room temperature is 0.5 °C above the setpoint, the thermostat stops heating. When the room temperature is 0.5 °C below the setpoint, the thermostat starts heating.

The temperature switching differential work cannot be directly influenced by the user.

11.2 Technical specifications

Please refer to the [datasheet of this product](#) for technical specification details.

11.3 Cyber security disclaimer

Siemens provides a portfolio of products, solutions, systems and services that includes security functions that support the secure operation of plants, systems, machines and networks. In the field of Building Technologies, this includes building automation and control, fire safety, security management as well as physical security systems.

In order to protect plants, systems, machines and networks against cyber threats, it is necessary to implement – and continuously maintain – a holistic, state-of-the-art security concept. Siemens' portfolio only forms one element of such a concept.

You are responsible for preventing unauthorized access to your plants, systems, machines and networks which should only be connected to an enterprise network or the internet if and to the extent such a connection is necessary and only when appropriate security measures (e.g. firewalls and/or network segmentation) are in place. Additionally, Siemens' guidance on appropriate security measures should be taken into account. For additional information, please contact your Siemens sales representative or visit <https://www.siemens.com/global/en/home/company/topic-areas/future-of-manufacturing/industrial-security.html>.

Siemens' portfolio undergoes continuous development to make it more secure. Siemens strongly recommends that updates are applied as soon as they are available and that the latest versions are used. Use of versions that are no longer supported, and failure to apply the latest updates may increase your exposure to cyber threats. Siemens strongly recommends to comply with security advisories on the latest security threats, patches and other related measures, published, among others, under <https://www.siemens.com/cert/en/cert-security-advisories.htm>.

11.4 Limited warranty

The software included in this product is licensed for use subject to the Siemens end-user license agreement (EULA) posted at www.siemens.com/smart-thermostat or this software identified by product model or part number on the website. The

open source software (OSS) information about the software can also be found from the same website

Issued by
Siemens Switzerland Ltd
Building Technologies Division
International Headquarters
Theilerstrasse 1a
CH-6300 Zug
+41 58 724 2424
www.siemens.com/buildingtechnologies

© Siemens Switzerland Ltd, 2019
Technical specifications and availability subject to change without notice.